

FAMILY
inada chair ROBOSTIC

HCP-D6A

Thank you for purchasing the Inada Chair ROBOSTIC.
 We hope the Inada Chair ROBOSTIC will be a valued partner
 in your daily health preservation for many years to come.

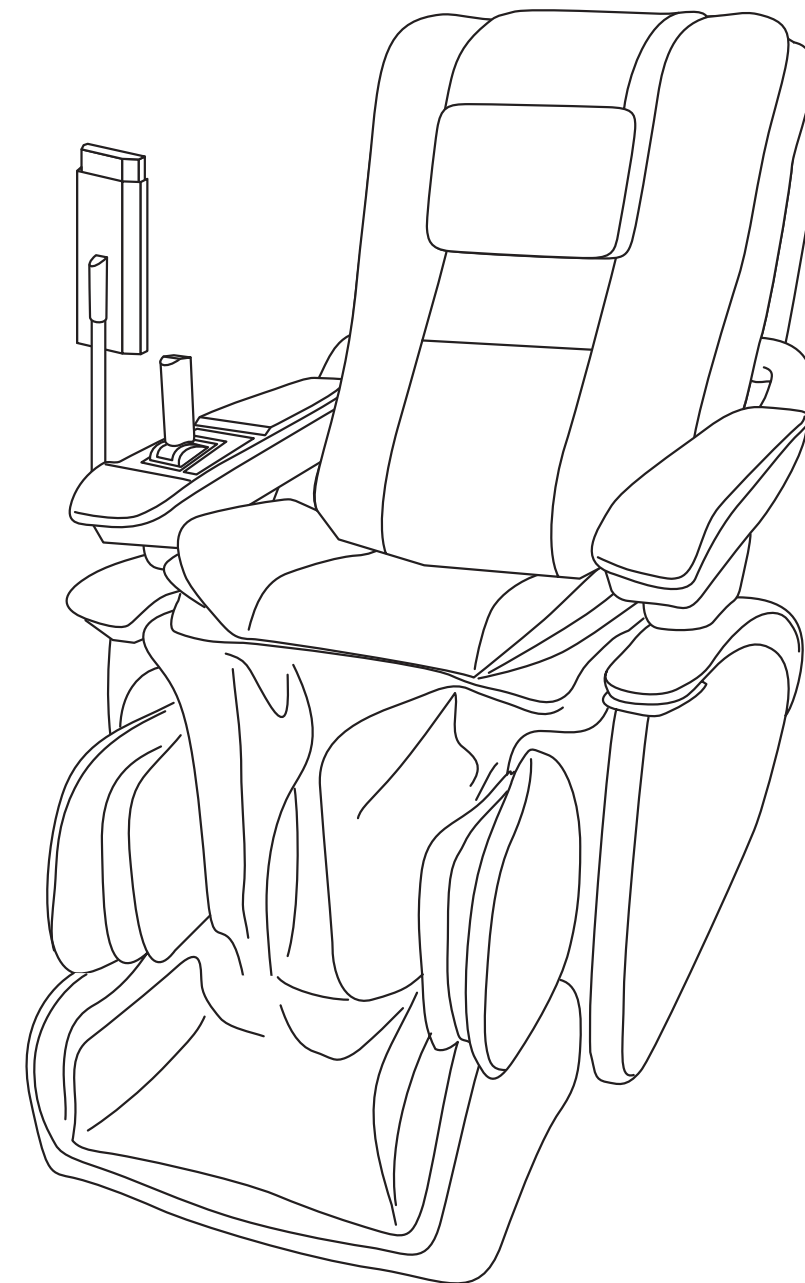

CONTENTS

■ SAFETY PRECAUTIONS.....	1
■ MAIN FEATURES.....	4
■ COMPONENTS & DESCRIPTION....	5
■ BEFORE USE.....	9
■ POSITION ADJUSTMENT.....	12
■ AFTER USE.....	16
■ MASSAGE PROGRAMS & SELECTION ..	17
■ MANUAL SELECTION MODE....	19
■ HEALTHCARE PROGRAMS.....	25
■ TROUBLESHOOTING.....	27
■ FAQ.....	30
■ CARE & STORAGE.....	31
■ CUSTOMER SERVICE AND WARRANTY....	32
■ REGULAR MAINTENANCE FOR SAFETY....	33
■ SPECIFICATIONS.....	34

FAMILY INADA INC.

US Headquarters: 7 West 56th Street, New York, NY 10019

Toll-free: 1-877-22-INADA(1-877-224-6232)

Technical assistance: 10:00 -17:00 (Eastern Standard Time) / Closed: Saturdays, Sundays, and Public Holidays
<http://www.inada-chair.com>

776395700

For U.S. Model Only

- Please read this Operating Manual before use.
- Keep this manual nearby so that you can refer to it anytime.

Operating Manual

Warranty card provided separately

SAFETY PRECAUTIONS

Be sure that you have read these SAFETY PRECAUTIONS thoroughly before using your ROBOSTIC for the first time. The Operating Manual contains important information about how to use the chair safely and correctly, avoiding possible damage to property or injury to persons using the chair and others. The symbols shown below are used throughout the Operating Manual to highlight important safety instructions. Please adhere to all precautions. Descriptions of each chair component can be found on pages 5-8.

Display Warnings





 Warning	This action could result in serious injury or death.	 Caution	This action could result in personal injury or damage to property.
--	--	--	--

Types of Symbols and Description





 Warning or caution	 Prohibited	 Do not disassemble	 Do not touch	 Do not use in or near water such as in a bathroom
	 Required action	 Electrical grounding	 Unplug the chair	

Remember to keep this Operating Manual in an easily accessible place.

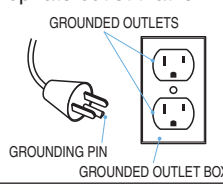

Safety Precautions: Installation

 Caution	 Do not install the chair in an area of high humidity such as a bathroom or sauna. →Could result in injury or electric shock.	 Do not use the chair outdoors.
 Required Action	Only install on a flat, level surface. →Chair could tip over accidentally if placed on an uneven surface.	



Safety Precautions: Before Use

 Warning	<ul style="list-style-type: none"> Space Requirements This product must be grounded. If it should malfunction or breakdown, grounding provides a path of least resistance for electric current in order to reduce the risk of electric shock. This product is equipped with a cord having an equipment-grounding conductor and a grounding plug. The plug must be plugged into an appropriate outlet that is properly installed and grounded in accordance with all local codes and ordinances. Improper connection of the equipment-grounding conductor can result in the risk of electric shock. Check with a qualified electrician or serviceman if you are in doubt as to whether the product is properly grounded. Do not modify the plug provided with the product if it will not fit the outlet; have a proper outlet installed by a qualified electrician. This product is for use on a nominal AC 120V circuit and has a grounding plug that looks like the plug illustrated in the figure to the right. Make sure that the product is connected to an outlet having the same configuration as the plug. No adapter should be used with this product. 	
 Prohibited	<ul style="list-style-type: none"> The following persons must not use this massage chair: <ul style="list-style-type: none"> Persons who have been instructed by a doctor to avoid massage therapy. Ex. Thrombosis, severe aneurism, acute varicosity, or dermatitis and/or skin infection including inflammation of the hypodermis. Persons with suspected acute neck sprain (whiplash injury). 	
 Required Action	<ul style="list-style-type: none"> Persons with any of the following conditions should seek medical advice before using the chair. <ul style="list-style-type: none"> Serious heart conditions Sensory impairment caused by serious peripheral circulatory disorders due to diabetes and other diseases Osteoporosis, spinal fractures, acute pain and/or symptoms thereof Persons being treated for personal injuries High fever (100°F or higher) Ex. Strong acute inflammation illness caused by fatigue, chills, blood pressure fluctuation, or asthenia Persons in the early stages of pregnancy, or immediately after giving birth Persons who have electronic medical device(s) easily susceptible to electromagnetic interference Ex. pacemaker Abnormal or curved spine Persons planning to use the chair for treatment or for rehabilitation purposes Persons with malignant tumor(s) Persons under bed rest orders Persons with acute gastro-intestinal complaints or ailments such as gastritis, enteritis, or hepatitis Persons under a doctor's care, or those experiencing unusual physical discomfort Joint dysfunction due to rheumatism, gout, or other diseases Persons with symptoms such as qualm, dizziness, or tinnitus Inflammation due to sprain or torn muscles Persons who are unable to communicate; and persons who are physically challenged 	
 Prohibited	<ul style="list-style-type: none"> Do not use the chair with anything other than an AC 120 V power source. →May result in fire or electric shock. Do not use with any type of transformer device. →May result in injury or electric shock. Do not use if the power cord or plug(s) is damaged, or if the wall outlet is loose. →May result in electric shock, short circuit, or combustion. Before each use, check for holes or tears in the chair covering (lift the back pad to check the seat back). Also, check other parts for tearing. Stop using the chair immediately if you find even the smallest tear. Unplug the chair and contact the vendor for assistance. →Using the chair with holes or tears in the covering could result in injury or electric shock. 	

Safety Precautions: Before Use

 Caution	<ul style="list-style-type: none"> Make sure that the main POWER switch on the chair is set to OFF before plugging the power cord into the wall outlet. →May result in injury or electric shock. Make sure that the plugs on the power cord are inserted fully into the cord connector and the wall outlet. →May result in electric shock, short circuit, or combustion. Before using the chair for the first time, turn on all the power switches in order as indicated in this manual to check that the chair is operating properly. Before using, raise the reclining seat to its fully upright position. Then recline the seat back slowly to the most comfortable position, remembering to start off with a lighter massage. →Starting with a deep massage can result in injury. Elderly people and persons with weak bones should be especially careful when selecting massage intensity. When sitting down in the chair, do so slowly, ensuring that the spinal rollers are in the correct position at either side of the spine. The backbone should lie comfortably between the rollers without having to turn or twist the body. Do not sit, stand, or lean on the footrest unless you are sitting in the chair or getting up from the chair. →Personal injury or damage to the chair may result if the chair tips over. If you have not used this chair for a period of time, reread this Operating Manual to ensure correct usage.
 Required Action	<ul style="list-style-type: none"> Do not use the chair in any way not prescribed by the Operating Manual. Do not use the chair together with any other therapeutic device or with an electric blanket. →May result in injury or have a negative effect on health. Do not move the chair while someone is in it. →Accident or injury may result if the chair tips over.
 Prohibited	

Safety Precautions: During Use



 Warning	<ul style="list-style-type: none"> Do not wrap the power cord or the remote control cord around the chair, or place the chair on top of either cord. Do not scratch, tear, treat, unduly twist, stretch, or bend the power cord or the remote control cord. →Cord may fray or tear, resulting in fire or electric shock. Do not spill or drop water on the chair or the remote control. →May result in electric shock, short circuit, or combustion. Children should not use the chair. It is advisable to keep children and pets away from the chair (especially behind the reclining seat back or under the seat or footrest). →May result in accident or injury. Do not use if the chair covering is torn. Unplug the power cord from the wall outlet. →May result in injury, accident, or electric shock. Contact the vendor for repairs. Do not place fingers or objects between the footrest units, footrest and chair, or armrest and chair. Do not release hands suddenly while lifting the footrest manually. Do not sit on or get out of chair with the footrest raised.
 Prohibited	
 Required Action	<ul style="list-style-type: none"> Do not use the chair while the body is wet, or with wet hands. →May result in injury or electric shock. Be sure that there is nobody (especially children), no pet or object around this chair before reclining the seat back or lowering the footrest. Be careful not to catch any part of the body or object behind it when reclining the seat back. Be careful not to get hands, feet, or objects caught in between the footrest units when activating the foot slide function. →May result in accident or injury.

Caution



 Prohibited	<ul style="list-style-type: none"> Do not use the chair unclothed. Do not use the chair for purposes other than massage, or other than the ordinary uses of a chair. →May result in accident or injury. Do not use the chair to massage the head, chest, stomach, and/or joints (knees, elbows). Do not place hands, feet, or arms in between the rollers. →May result in nausea or injury. Place a soft towel behind your neck if you want to avoid intense stimulation of the area. Do not place hands or feet into the roller tracks, into the space between the seat back and the seat or into the moving parts. Do not sit wearing hard objects like hair accessories. →May result in personal injury. Do not place anything other than legs and feet on the footrest. →May result in personal injury. Do not operate the massage chair or leave it operating when there is no one in it. →May result in accident or injury.
---	---

SAFETY PRECAUTIONS



Safety Precautions: During Use

⚠ Caution	
 Required Action	<ul style="list-style-type: none"> ● In an emergency, or if there is any sudden malfunction, push the STOP button on the remote control to make the chair stop immediately. ● If you begin to experience marked pain or other unusual physical discomfort while using the chair, seek medical advice immediately and discontinue use of the chair. ● If you feel the massage is too strong, reduce the stimulation according to this Operating Manual. If this solution does not work, stop using and contact the vendor. →May result in injury if you continue use with high stimulation under such circumstances. ● Make sure to keep the back pad in place during massage. Do not use the chair without the back pad. →May result in personal injury. ● Do not fall asleep in the chair during a massage. →May result in personal injury. ● Keep massage sessions to no more than 15 minutes in length. Area Specific Massage of any particular area on the body to no more than 5 minutes. →Continual use for extended periods of time can result in over-stimulation, which could cause the opposite of the desired effect, or even injury. Set 30 minutes in total for reference per day and keep appropriate intervals between each massage session. ● If your leg or foot comes out of the footrest during the massage, do not try to force it back in. →Undue force may result in damage to the mechanism.
 Unplug	<ul style="list-style-type: none"> ● If there is a power outage or the possibility of a power outage, stop the chair immediately and turn the main POWER switch to OFF. Unplug the chair from the wall outlet. →Accident or injury may result if the chair is still in operating mode when the power resumes. ● If there is a threat of lightning, stop the chair immediately and turn the main POWER switch to OFF. Unplug the chair from the wall outlet. ● If the chair does not start, or if there is any type of malfunction, to prevent accidents it is best to stop the chair immediately and turn the main POWER switch to OFF. Unplug the chair from the wall outlet. Contact the vendor for assistance regarding repairs or maintenance. →Electric shock or fire caused by a short circuit may result if the chair is left plugged in under such circumstances.

Safety Precautions: After Use or When Not in Use

⚠ Caution	
 Required Action	<ul style="list-style-type: none"> ● Make sure to turn the main POWER switch to OFF after every use and to unplug the chair from the wall outlet. →Accident or injury may result if children or pets try to play with the chair. ● Make sure to return the reclining seat back to the upright position and lower the footrest completely after using the chair. ● Wipe the chair off after every use, and store your chair in a place free of excess humidity. ● Do not place any object on the seat, reclining seat back, armrest, footrest, sub remote control, and/or joystick.
 Unplug	<ul style="list-style-type: none"> ● Do not pull on the power cord to unplug the chair from the wall outlet; make sure to grasp the plug firmly when unplugging. →May result in electric shock or short circuit, which could in turn result in fire. ● When cleaning or caring for the chair, make sure to unplug the chair from the wall outlet first. Do not touch the power cord with wet hands. ● If you will not be using the chair for some time, make sure to unplug it from the wall outlet. →Dust and moisture can cause electrical insulation to deteriorate, resulting in possible electric shock, short circuit, or fire.

Others Precautions

⚠ Warning	
 Prohibited	<ul style="list-style-type: none"> ● Do not stand on the chair. Do not sit on any part of the chair other than the seat. →Personal injury or damage to the chair may result if the chair tips over. ● Do not sit on or get out of chair with the footrest raised. ● Do not stand on the control box and/or place any object on it.
 Do not disassemble	<ul style="list-style-type: none"> ● Do not remodel the chair. Anyone other than an authorized serviceperson must not repair or disassemble. →May result in fire, electric shock, or injury. Contact the vendor for repairs.

⚠ Caution	
 Required Action	<ul style="list-style-type: none"> ● If you lend, sell, or otherwise transfer the chair to another party, make sure to include this Operating Manual.

MAIN FEATURES

Main Features

Rollers, air pressure, and vibration combined Hybrid Massaging Function

The ideal relaxation, realized by all of our available technology.

For the back, buttocks, and calves, a rich variation of massage techniques and unique programming make for a close to "human touch" sensation. The foot unit, designed to massage the soles of the feet, moves together with the reclining seat back to keep the foot massage going at any angle.

With full fine adjustment Joystick Function

Select massage action, intensity, and roller position through simple operation of the joystick.

Optic sensors provide for Automatic Shiatsu Point Locator Function

Automatically locates shiatsu points which vary from person to person. This allows for an effective massage that tailors itself to your size and shape.

Easy to read massage guide Remote Control Display Panel

The remote control features a clear, easy to read display panel that enables you to monitor your massage. The display guides you through each step of your massage, displaying information about each massage action.

Easy to adjust to the most comfortable position Automatic Reclining Function

The seat back can be reclined to any angle between approx. 120° and 170°. The footrest can be raised to an approx. 90° angle. Both can be easily adjusted to find the most comfortable position for you.

Vibration Massage Function

Vibration mechanisms are located in the seat, footrest (foot unit), and chair back. The soothing vibrations make for a relaxing massage.

With state-of-the-art technology Various Course Functions

10 healthcare programs (auto) and manual selection modes can be selected to satisfy your particular needs.

Standard Remote Control Stand

A standard remote control stand is available which accommodates the remote control.

Foot massage unit stays on the soles of your feet Foot Slide Sensors

The footrest activates whenever you choose to recline the seat back. After reclining, the footrest length is adjusted automatically to provide a calf or foot massage according to your leg length.

Benefits

As a therapeutic massage device, the ROBOSTIC provides the following benefits:

- Relaxes muscles
- Relieves minor muscle aches and pains

COMPONENTS & DESCRIPTION

Chair

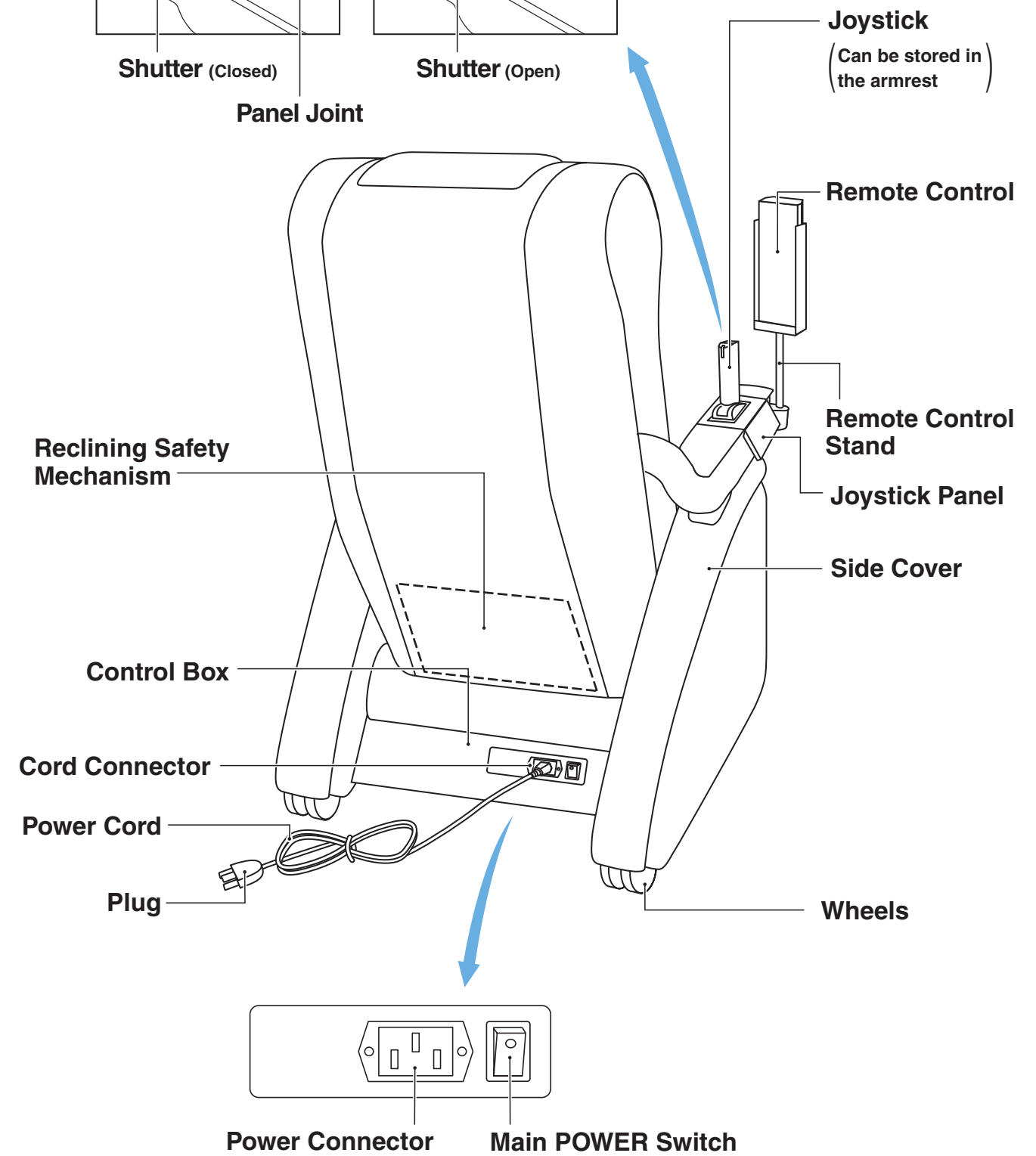
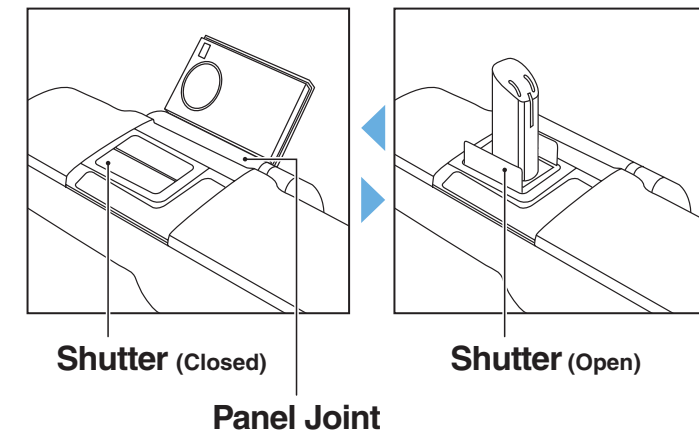
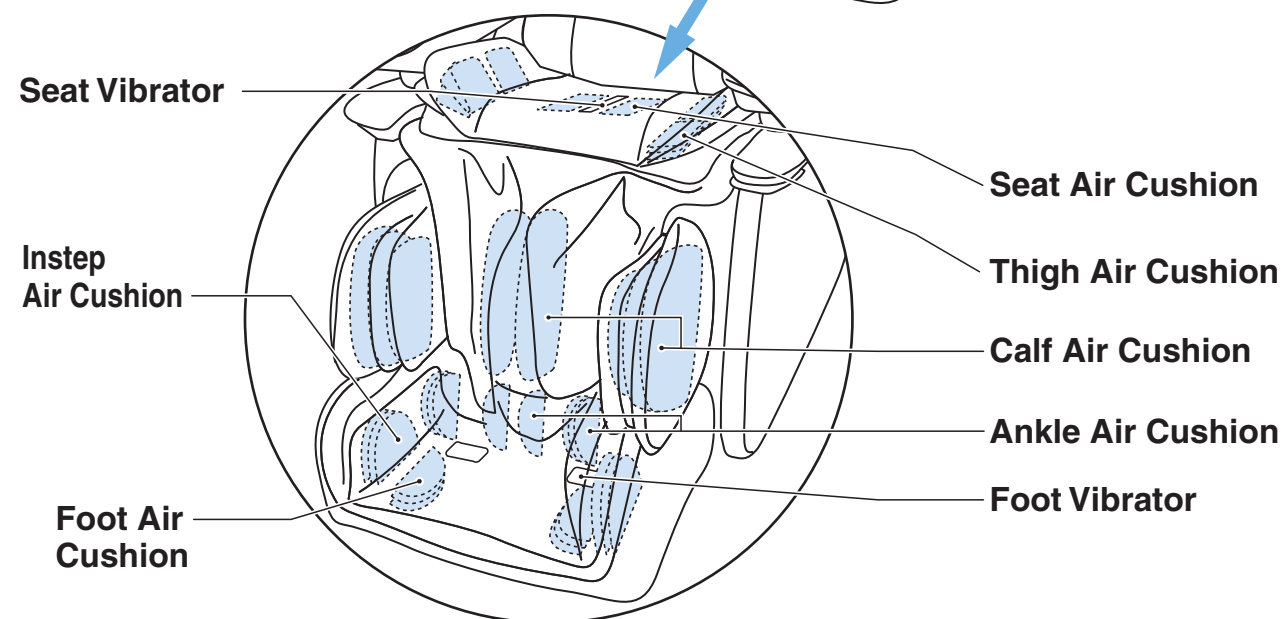
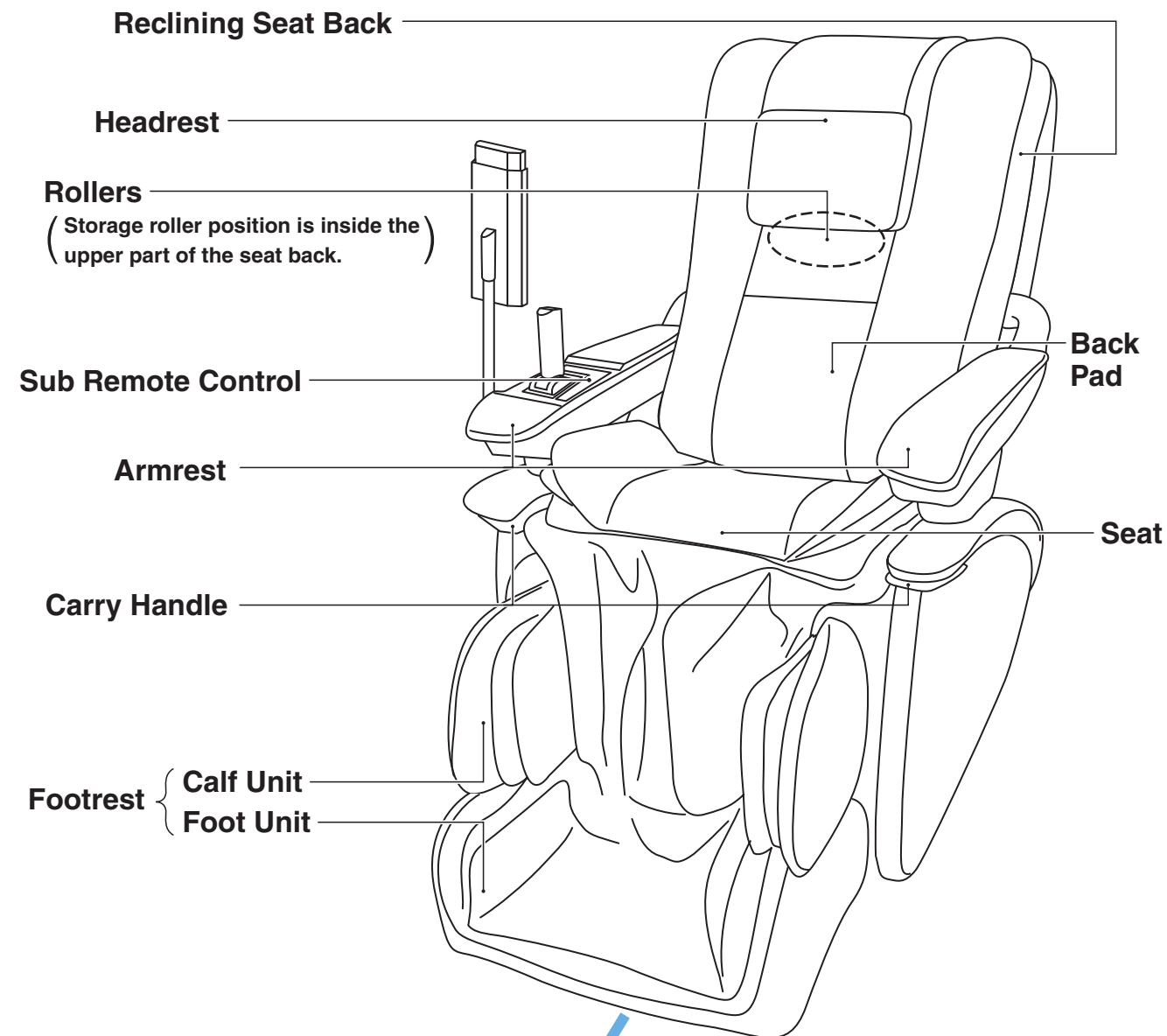

[COMPONENTS & DESCRIPTION]

[COMPONENTS & DESCRIPTION]

COMPONENTS & DESCRIPTION

Remote Control

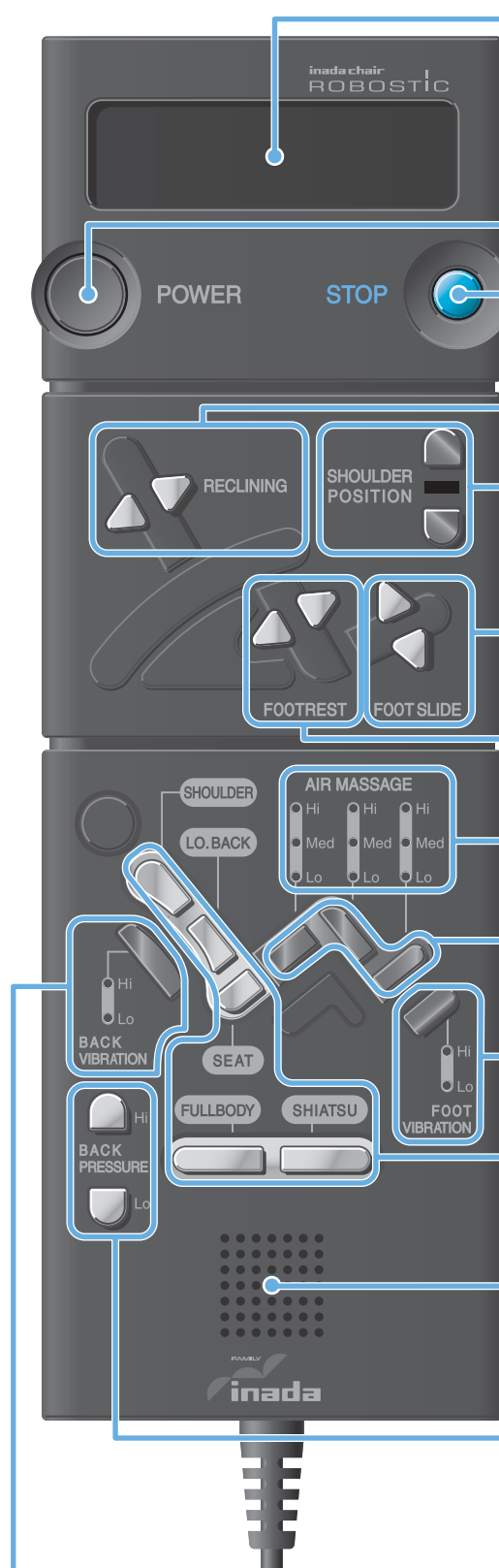

Remote Control Display
Displays information such as massage action description and intensity (See right).

POWER Button
Turns the remote control power ON and OFF. Pushing the POWER button while the chair is activated causes the rollers to return to the starting position, after which the chair turns itself off.

STOP Button
Use this button to shut the chair off immediately in case of emergency or if there is some malfunction during operation of the chair. Rollers will not be returned to the storage position.

Reclining Buttons
Use [▲] and [▼] to adjust the angle of the reclining seat back (See page 12).

Shoulder Position Adjustment Buttons/Lights
Adjusts shoulder position while Shoulder Position Light is on (See page 21 or 25).

Foot Slide Buttons
Use [▶] and [◀] to adjust the length of the foot slide (See page 13).

Footrest Button
Use the [▲] and [▼] to adjust the angle of the footrest (See page 13).

Air Massage Light
Displays the status of each air massage action.

Air Massage Buttons
Adjusts air massage intensity for Healthcare Programs and Manual Selection Mode.

Foot Vibration Light
Displays the status of foot vibration (See right).

Foot Vibration Button
Sets foot vibration and adjusts intensity for Healthcare Programs and Manual Selection Mode.

Healthcare Program Buttons
Selects program with corresponding course name (See page 17).

Speaker

Back Pressure Buttons
Controls depth of massage by pushing out or by withdrawing the rollers.
Available only under Healthcare Programs (See page 26).

Back Vibration Light
Displays the status of back vibration.

Back Vibration Button
Sets back vibration and adjusts the intensity of Healthcare Programs and Manual Selection Mode.

Remote Control Display/Light

Remote Control Display

Displays information about the massage action, time remaining, and speed and intensity settings, using both text and symbols. Characters and illustrations on the display move from right to left.

Example: While the Shiatsu Point Locator sensors are being activated, the display shows the following text: "Locating Shiatsu Points..."



Air Massage Light

Displays the status of air massage for seat, calf, and feet in 4 settings: off, low, medium, and high.

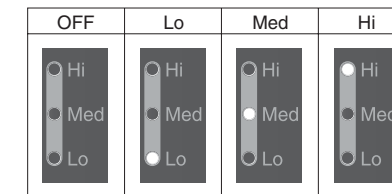

Vibration Light

Displays the status of back/foot vibration in 3 settings: off, low, and high.

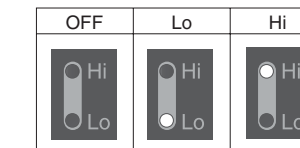

Shoulder Position Adjustment Light

Illuminates when Shoulder Position Adjustment Buttons are usable.



Sub Remote Control/Joystick (Manual Selection Mode) /Right Armrest

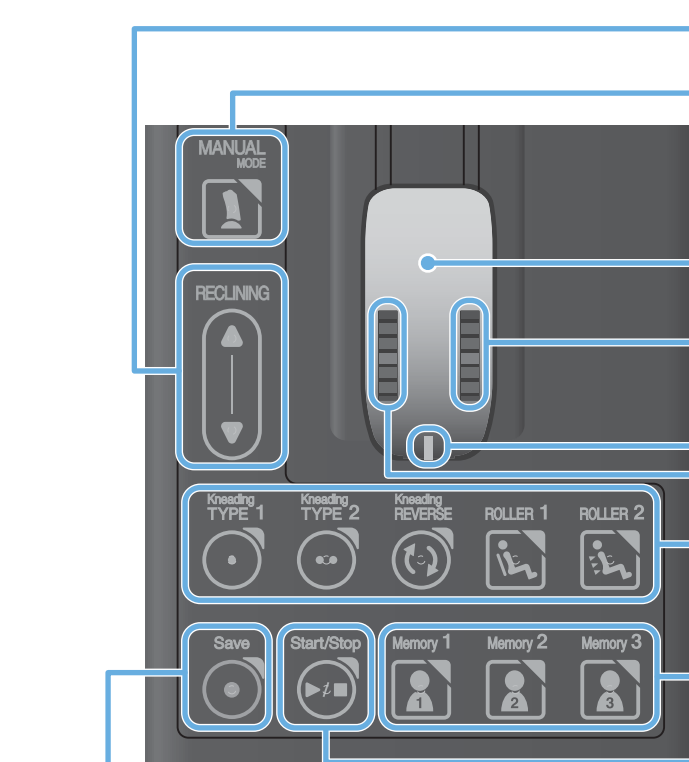

Reclining Button
(See page 12)

Manual Selection Mode Button
This button activates the Manual Selection Mode. If the button is pressed once again, the operation will stop after the rollers return to Storage Position (see page 20).

Joystick
Adjusts the roller position by moving back and forth or up and down (See page 19).

Tapping Dial (See page 20)

Joystick Light (See page 20)

Kneading Dial (See page 20)

Manual Selection Mode Buttons
Selects among Kneading Type 1, Kneading Type 2, Kneading Reverse, Roller 1, and Roller 2 (See page 20).

Memory Buttons
Recalls saved operation (See pages 22 and 23).

Start/Stop Button
Starts/Stops saved operation (See pages 22 and 23).

Save Button
Saves massage action set with joystick and/or in Manual Selection Mode (See page 22).

Warning

- Do not spill water and/or other liquids on the remote control, sub remote control, and/or joystick.
- Do not handle the remote control with wet hands.
- Do not sit on the remote control, sub remote control, and/or joystick. Do not drop or step on the remote control. Do not pull the remote control cord forcibly.
- Do not use pointed or hard objects to push the buttons or display on the remote control. →May result in damage to the remote control.

BEFORE USE

- **This product is shipped with the reclining seat back in its fully reclined position. Be sure to raise the seat back to its fully upright position.**
→When turning on the POWER switch without the footrest attached, the message "Restart the main POWER switch." appears on the remote control. This does not mean that the remote control switch is out of order.
- **Do not expose the chair to sudden bursts of heat. If the room where the chair is to be used is cold, turn the heat up slowly. If the chair is moved from a cold place into a heated room, wait one hour before using the chair.**
→Condensation could occur in the moving parts of the chair, which may compromise performance.

Installation

Allow for at least 20 inches clearance behind the chair and 16 inches in front of the chair when installing, so as to be able to recline the seat back fully without obstruction.

Caution

- Do not use in areas of high humidity such as bathrooms or saunas.
- Only install on a flat, level surface.
- Do not use in areas of high debris or dust content. Do not use where ambient temperature is 100°F or over.
- Do not install the chair where it can come into contact with direct heat, such as direct sunlight or a radiator.
- To avoid damaging floor surfaces and to cut down on the noise of the chair, it may be better to install the chair on a carpeted surface or to lay a piece of carpet under the chair (Do not use electric blanket).
- The chair is very heavy, so please be careful when unloading it so as not to damage floor surfaces.
- Install the chair at least 40 inches away from TVs, radios, and/or other audio or video equipment. Noise from these devices can cause problems.
- When a person who weighs 220 lbs. or more sits on the chair, approx. 9.5 lbs. load per 0.16 in² will press on to the floor.

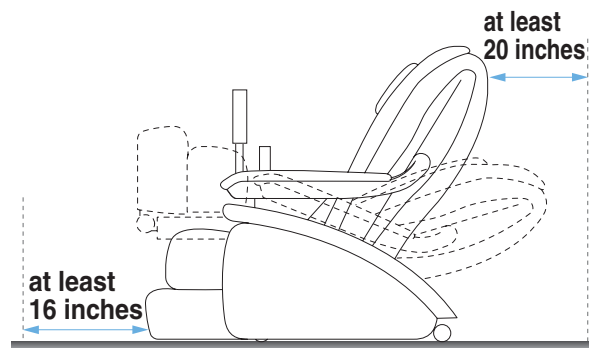

Main Power Connection

- (1) Plug the power cord into the cord connector located at the back of the chair first. Then plug the other end into the wall outlet.

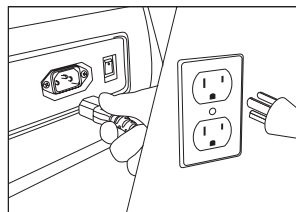

- (2) Turn on the main POWER switch on the back of the chair. A text message should appear on the remote control display screen.

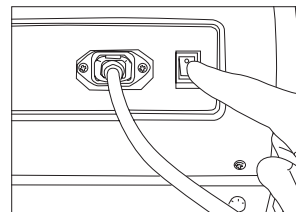

*When the rollers stop mid-massage, turning the main POWER switch ON again will reset the rollers to the starting position (upper part of seat back). The chair will then turn itself off.

Warning

- Do not use with any type of transformer device.
→May result in injury or electric shock.

Caution

- Before plugging the power cord into the wall outlet, make sure that the main POWER switch is set to OFF.
- Make sure that the plugs on the power cord are inserted fully into the cord connector and the wall outlet.
- Before using the chair for the first time, turn on all the switches in order as indicated in this manual to check that the chair is operating properly.

Installing Remote Control Stand

Attach A to B on the outside of the right armrest using the screws provided. Be sure to tighten both screws. To place the remote control on the stand, run the remote control cable through the cable guide of the remote control stand.

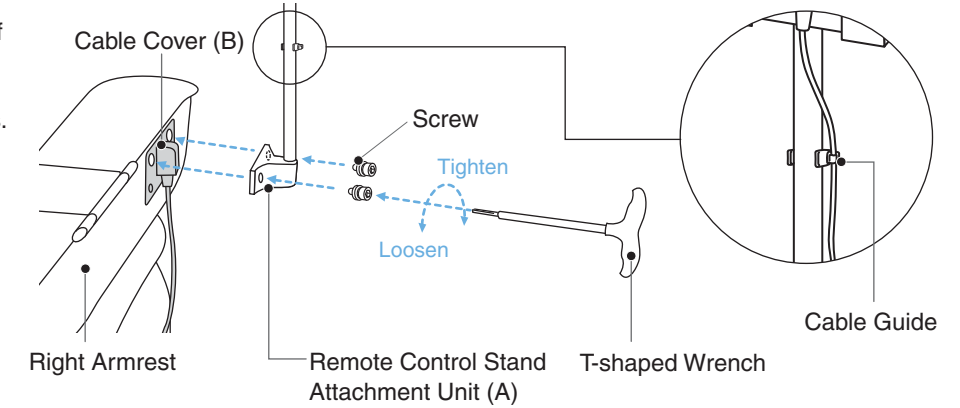

BEFORE USE

Checking Seat Cover

Check for tearing on the chair by unzipping the upper part of the reclining seat back and lowering the back pad as illustration shows.

Warning

- Check for tearing on the chair by lowering the back pad before use. Also, check the other parts. Stop using the chair immediately if you find even the smallest tear. Unplug the chair and contact the vendor for assistance.

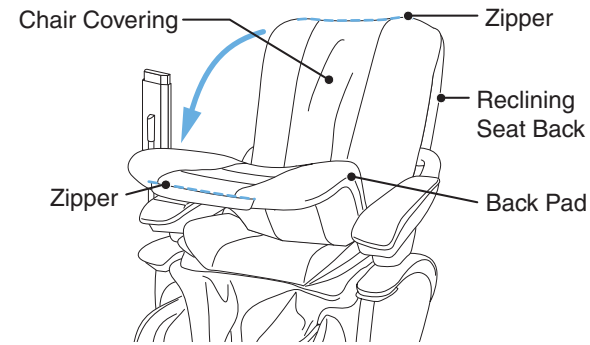

How To Move The Chair

The chair is equipped with wheels that make it easy to move. First, raise the reclining seat back and turn the main POWER to OFF. Then, unplug the power cord from the outlet and lift the chair up with another person as shown in illustrations (2) and (3) by holding the carry handles shown in illustration (1). Wheel in the desired direction with the front part lifted up.

(1) Carry Handle

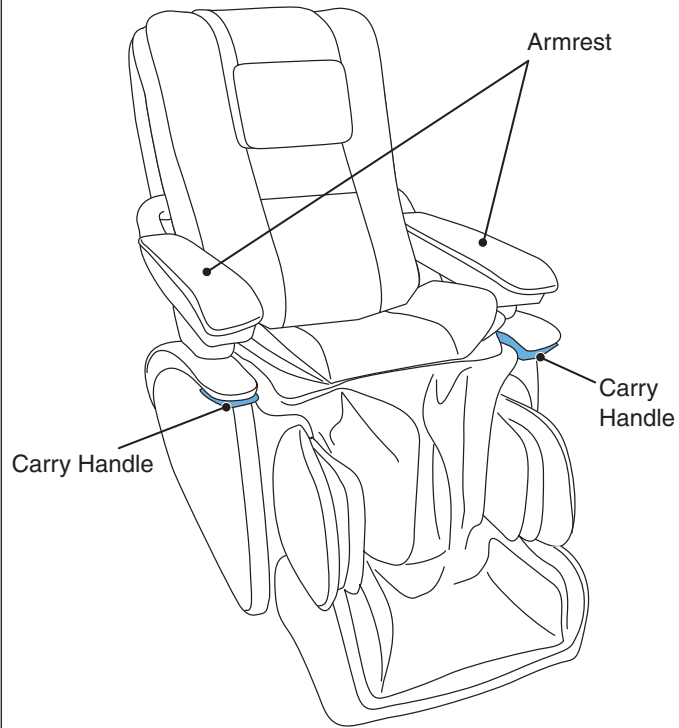

Caution

- Hold the carry handle, not the armrest, for movement.
- Do not move the chair while someone is on it.
- Be careful not to get feet caught underneath when moving the chair.

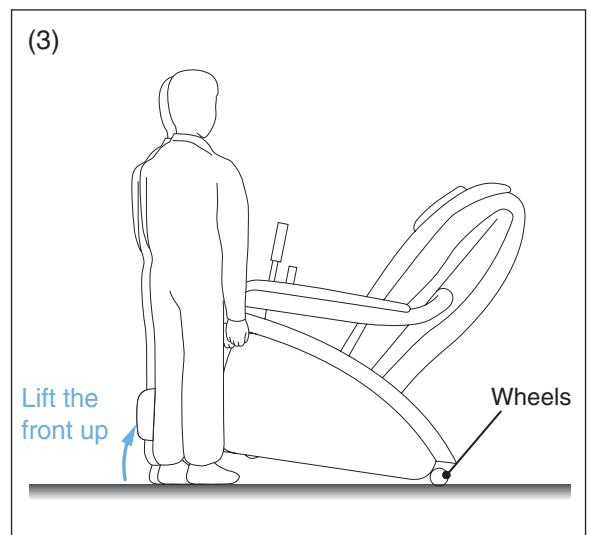
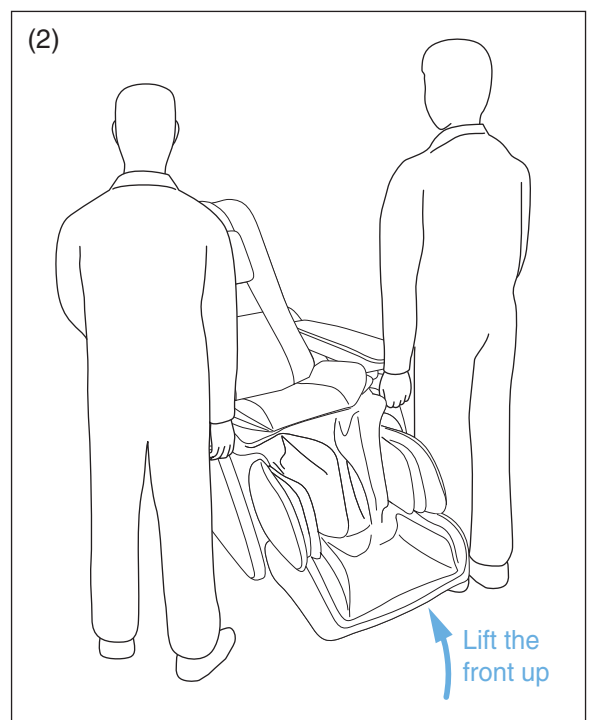

POSITION ADJUSTMENT

How To Sit

Make sure the footrest is down. When the chair is off, the rollers are normally drawn back into the left and right sides of the upper part of the seat back (Storage Position). For safety reasons, first check the position of the rollers. If they are in any position other than storage position, turn the main POWER switch on before sitting down to allow the rollers to return to the Storage Position. When you finish checking, sit down slowly in the center of the seat according to the instructions shown below.

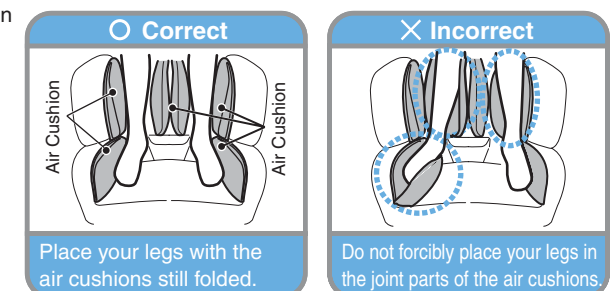
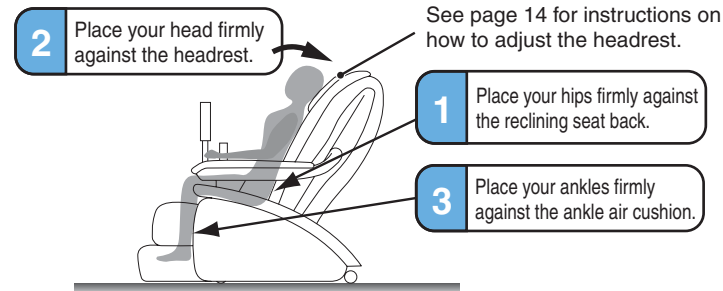

- ### Caution
- Before using, raise the reclining seat back to its fully upright position. Then recline the seat back slowly to the most comfortable position, remembering to start off with a lighter massage.
 - Do not sit down on the chair with the footrest raised. Any sudden heavy weight on the footrest could cause damage to the mechanism.

How To Use The Reclining Seat Back

- To raise the reclining seat back: Press and hold the Reclining [RECLINING] button on the remote control or upward Reclining button on the sub remote control. Release when you reach the desired position.

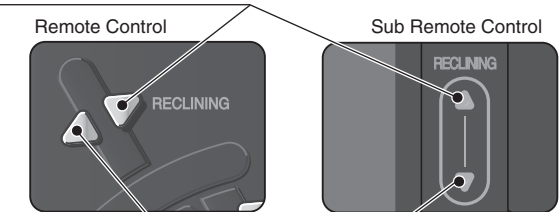

- To lower the reclining seat back: Press and hold the Reclining [RECLINING] button on the remote control or downward Reclining button on the sub remote control. Release when you reach the desired position.

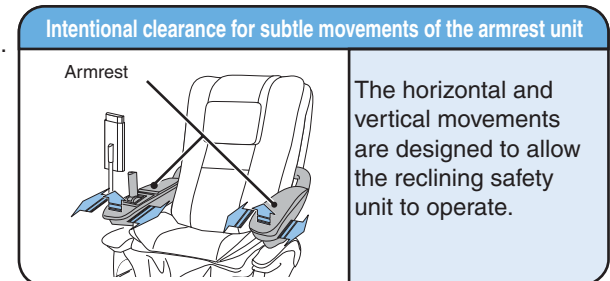
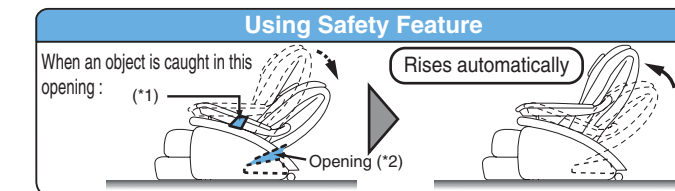

- You can use the Reclining button on the sub remote control when the joystick panel opens.
- The footrest activates whenever the reclining function is used. When the chair stops reclining, the footrest also stops moving. Then the foot slide function automatically extends or shortens the footrest to match the length of your legs.
- The foot slide automatic adjustment function becomes available when you release the Reclining button.
- After the foot slide stops, you can further adjust the footrest position using the Foot Slide buttons.
- If the main POWER switch at the back of chair is set to ON, you can adjust the reclining position.

- ### Warning
- Make sure no one, especially children or pets, is in the way when lowering the reclining seat back. Be careful that people and/or objects are not caught behind the seat back.
 - Do not place body or objects between the armrest and the chair when lowering the seat back.
 - When the opening (*1) safety unit is working, the reclining buttons (up, down) on the remote control or sub remote control are disabled.
 - When the opening (*2) safety unit is working, the reclining buttons (down) on the remote control or sub remote control are disabled.

[BEFORE USE]

[POSITION ADJUSTMENT]

POSITION ADJUSTMENT

How To Use The Footrest

To raise the footrest:

Press and hold the Footrest [] button on the remote control.
Release when you reach the desired footrest position.

Position that requires attention when the footrest is being raised.

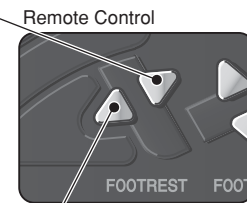
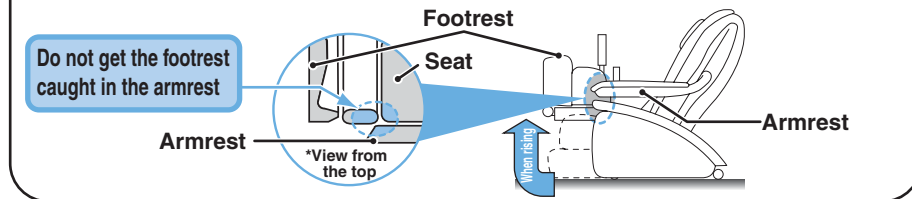

To lower the footrest:

Press and hold the Footrest [] button on the remote control.
Release when you reach the desired footrest position.

- When the footrest stops, the foot slide function automatically slides the footrest in or out to match the length of your legs.
- After the foot slide stops, you can further adjust the footrest position using the Foot Slide buttons.
- If the main POWER switch at the back of the chair is ON, you can adjust the footrest angle.

* If your ankles do not reach the wall of the foot unit, adjust the reclining position or the footrest position until the footrest fits firmly around the legs and feet.

Warning

- Make sure no one, especially children or pets, is in the way when lowering the footrest. Be careful that people and/or objects are not caught under the footrest.
- Be careful not to get hands caught when raising the footrest by hand.
- Do not release hands suddenly while lifting footrest by hand. Do not place fingers, legs, or objects between the footrest and the armrest when raising the footrest.

Caution

- Do not place anything other than the legs and feet on the footrest.

Foot Slide Automatic Adjusting Function

Foot Slide Sensors

The Foot Slide Adjusting Function uses sensors located in the ankle area of the foot unit to determine if the footrest needs to be lengthened or shortened.
Sit with your ankles firmly against the wall of the foot unit so that the sensors can work properly.

* If your ankles do not reach the wall of the foot unit, adjust the reclining position or the footrest position until the footrest fits firmly around the legs and feet.

To shorten the foot slide:

After the foot slide finishes its automatic adjustment, press the Foot Slide [] button on the remote control.

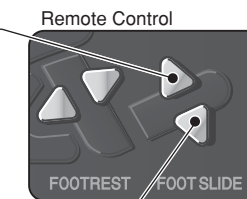
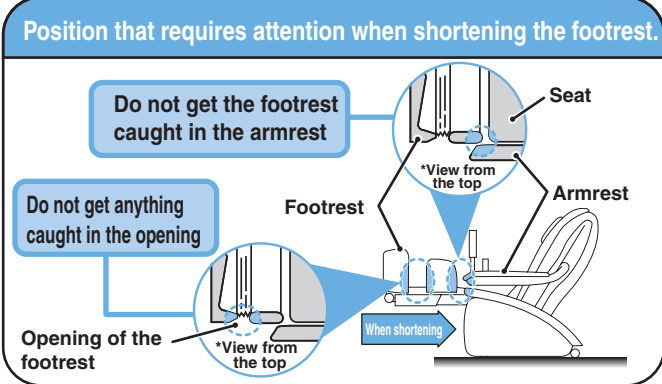

To extend the foot slide:

After the foot slide finishes its automatic adjustment, press the Foot Slide [] button on the remote control.

Warning

- Do not place fingers, legs, or objects between the footrest and the armrest when the foot slide function is in operation.

Headrest

Two headrests (small and large) are provided for use with the chair. Use them to keep your head in a comfortable, natural position during your massage.

- The small headrest pad is attached to the chair with velcro, so you can adjust the position. Adjust the small headrest to match the position of your head before starting the massage.

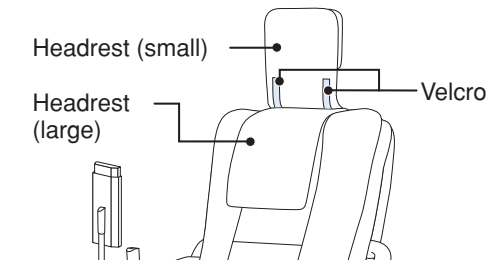

Buffer Pad

There is a buffer pad located behind the back pad that helps absorb some of the roller stimulation. Remove the buffer pad if you feel that the massage is too light. Replace with a thicker accessory buffer pad in case of the opposite.
To replace the buffer pad, unzip the top of the seat back and the lower back pad.

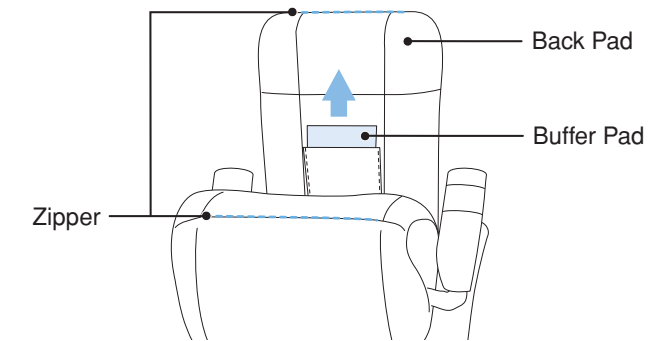

Shiatsu Foot Pad

The ROBOSTIC comes with a Shiatsu Foot Pad. The foot shiatsu mat can be placed in the foot unit if so desired.

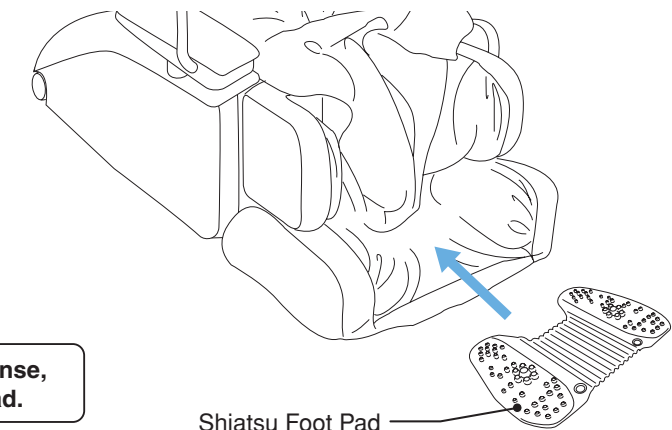

Caution

- If the stimulation is too intense, remove the Shiatsu Foot Pad.

POSITION ADJUSTMENT

How To Release And Store Joystick

You can store the joystick when unused.

How to release

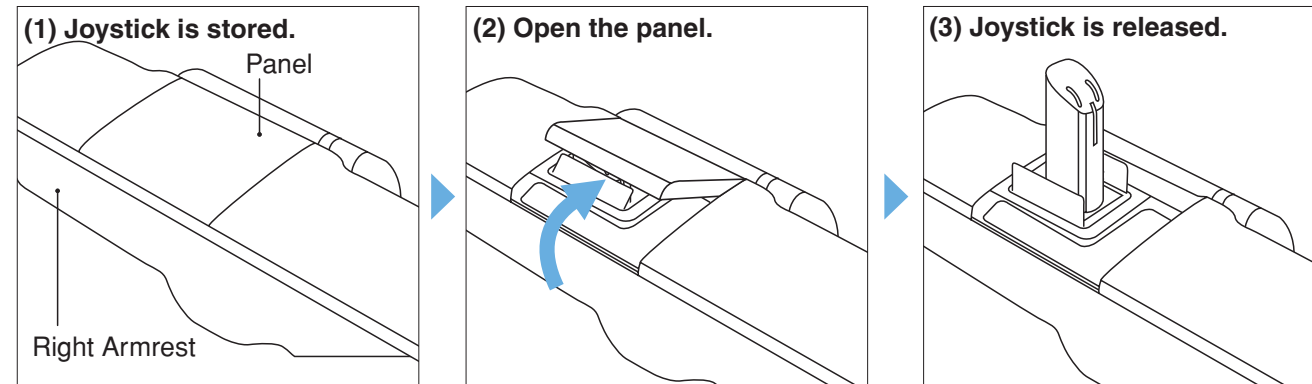

To release the joystick, lift the panel approx. 0.4 inch, as in (2). By doing so, the joystick automatically comes up and the panel opens accordingly (approx. 2 seconds).

* Joystick does not work when the remote control power is off. Press the POWER Button on the remote control for operation.

How to store

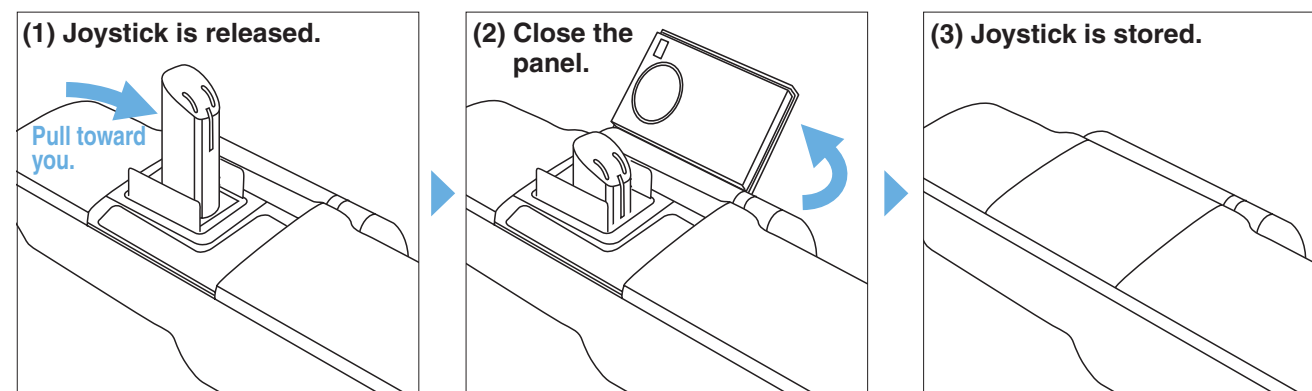

To store the joystick, pull the joystick toward you before closing the panel.

Do not forcibly push back the joystick.

* You can store even when remote control power is off.

Joystick Safeguard

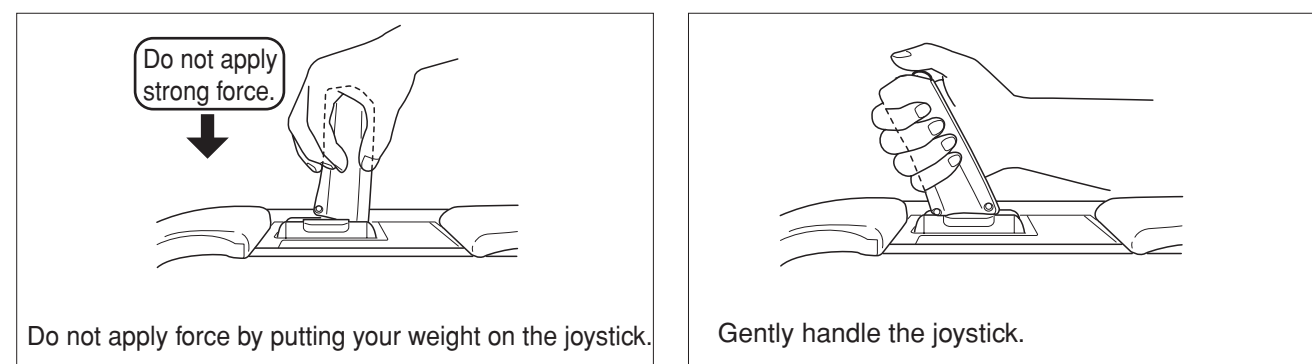

* If force more than 11 lbs. is applied from on top or in handling, the joystick drops. This is not failure, but a result of the safeguard function.

<p>Caution</p>	<ul style="list-style-type: none"> Do not place any object on the joystick panel. Do not forcibly pull up or bend the joystick to the side. →May result in personal injury or damage. Do not get your fingers caught when releasing or storing the joystick. The panel will not close depending on the joystick position when storing. Check the storage procedure.
-----------------------	--

[POSITION ADJUSTMENT]

AFTER USE

When You Stand Up

- Do not stand up by pulling on or by placing weight on the joystick or remote control stand.

* Always lower the footrest as shown in the illustration. Otherwise, you may get injured or break the chair. For operation of the reclining function, see page 12.

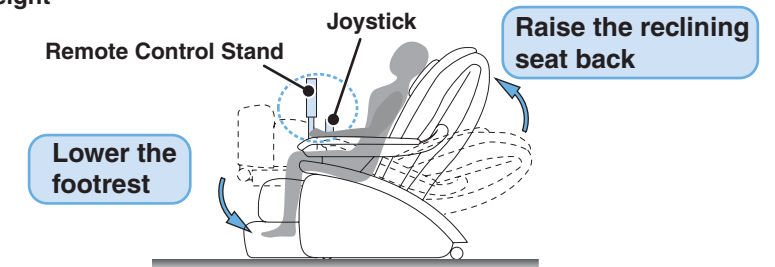

Caution

- Store joystick after usage. →Otherwise, you may get injured or break the chair.
- Make sure to turn the main POWER switch to OFF after every use and to unplug the chair from the wall outlet. →Accident or injury may result if children or pets play with the chair.
- Make sure to return the reclining seat back to the upright position and lower the footrest completely after using the chair.
- Wipe the chair off after every use, and store the chair in a place free of excess humidity.
- Do not pull on the cord to unplug the chair from the wall outlet; be sure to grasp the plug firmly when unplugging.
- If you will not be using the chair for some time, make sure to unplug it from the wall outlet.

[AFTER USE]

MASSAGE PROGRAMS & SELECTION

Types of Massage

Healthcare Programs

These automatic programs provide massages to meet your desired purpose and application. You can choose your favorite one from the program buttons on the remote control.

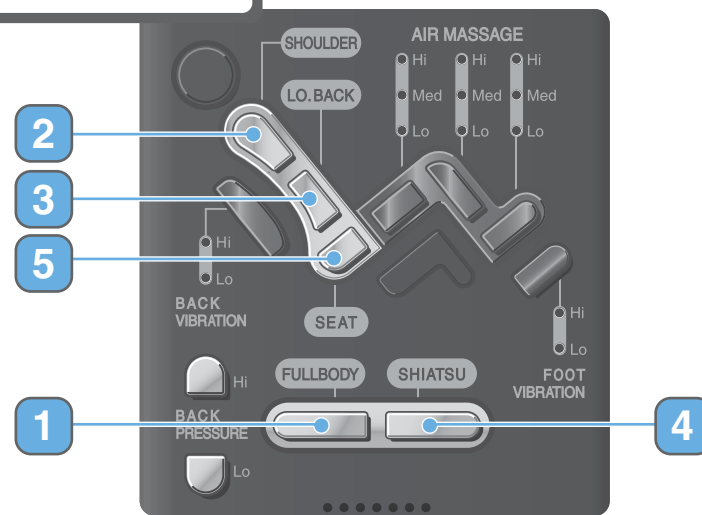

Manual Selection Mode

Massage speed, intensity, and position are adjustable through the remote control, sub remote control, and joystick.

3D program, provides 3D movement through "roller advancement and retraction"

Normal program provides a 2D movement

* You can switch between **3D** and normal programs by pressing the same program button of your choice during each program.
* During normal program operation, only the program name is shown on Remote Control Display.

1 Fullbody Relief 3D ↔ **Fullbody Relief (Normal)**

A comprehensive fullbody massage (approx. 15 minutes).

2 Stiff Shoulders 3D ↔ **Stiff Shoulders (Normal)**

Focused massage on the neck and shoulders (approx. 13 minutes).

3 Lower Back Tension 3D ↔ **Lower Back Tension (Normal)**

Focused massage on the lower back (approx. 12 minutes).

4 Shiatsu 3D ↔ **Shiatsu (Normal)**

Slow motion roller action massages the entire body (approx. 13 minutes).

5 Seat 3D ↔ **Seat (Normal)**

A combination of vibration and air pressure massage for the buttocks (approx. 12 minutes).

● The duration of each course varies depending on height, body type, reclining angle and other factors related to the user.

MANUAL SELECTION MODE

You can select and combine your favorite massage action using the remote control, joystick, or sub remote control.

* Massage action in the manual selection mode is indicated by green lights. The joystick is indicated by a blue light.

Remote Control

You can select air massage (seat, calf, foot) and vibration (back, foot) on the remote control.

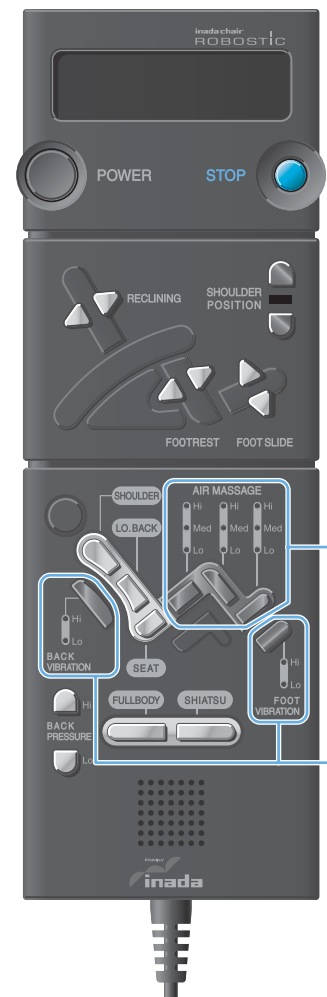

■ Air Massage Intensity Adjustment
Starts with [Medium].
In the illustration below, you can change in the following order every time you press one of the Air Massage buttons ① Seat, ② Calf, and ③ Foot.

Med → Hi → OFF → Lo

Display of Air Massage Lights

OFF	Lo	Med	Hi
Lo	Lo	Lo	Lo
Lo	Lo	Lo	Lo

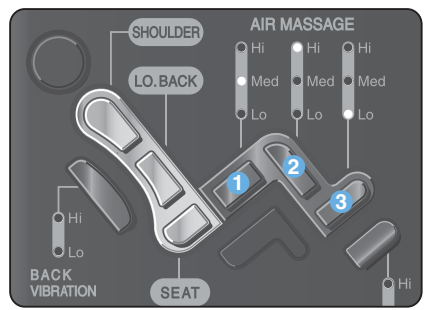

(Above illustration shows Seat set for [Med], Calf for [Hi], and Foot for [Lo].)

■ Vibration Intensity Adjustment
Starts with [Lo].
In the illustration below, you can change in the following order every time you press the ① Back Vibration or ② Foot Vibration button.

Lo → Hi → OFF

Display of Intensity Adjustment Lights

OFF	Lo	Hi
Lo	Lo	Lo
Lo	Lo	Lo

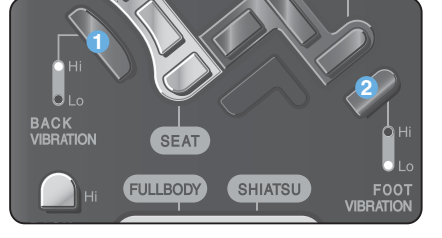

(Above illustration shows Back set for [Hi] and Foot for [Lo].)

Joystick & Sub Remote Control

You can adjust speed of Kneading and Tapping, massage intensity, and roller vertical positions using the joystick. The sub remote control is for selecting Kneading Reverse, Kneading Type 1&2, Roller 1&2, or the Memory Function.

■ Massage Intensity and Roller Vertical Position Adjustment

Operation	Action
Pull joystick up.	Roller moves upward.
Push joystick down.	Roller moves downward.
Push joystick forward.	Roller presses forward for higher massage intensity.
Pull joystick backward.	Roller withdraws for lower massage intensity.

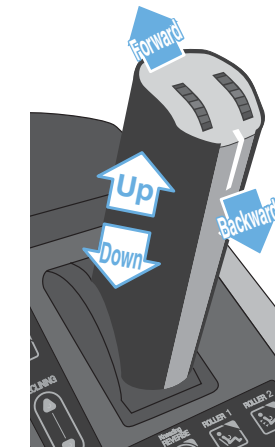

■ Manual Selection Mode Button
When you press this button, the upper right of the button blinks to enable the Manual Selection Mode using the joystick and sub remote control. When you press it again, the lights go off and operation stops after returning the rollers to Storage Position.
(Right illustration indicates manual selection program is underway.)



■ Joystick Light
Blinks when shoulder position adjustment is available or the joystick is needs to be pulled toward you. When blinking stops and the light is steady, the joystick is ready for operation.

■ Tapping Dial
Starts/Stops the tapping action and adjusts speed.

Operation	Action
Turn to Fast	Starts and accelerates the tapping action.
Turn to Slow	Slows down the tapping action. Stops when further rotated.



■ Kneading Dial
Starts/Stops the kneading action and adjusts speed.

Operation	Action
Turn to Fast	Starts and accelerates the kneading action.
Turn to Slow	Slows down the kneading action. Stops when further rotated.

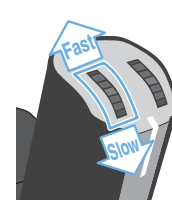

■ Kneading Reverse
Press this button to start kneading in reverse when the light in the upper right-hand corner is lit. To return to the original direction, press this button again.
(Left illustration shows that the Kneading Reverse action is underway.)



■ KNEADING TYPES

Action	Description
Kneading Type 1	Reproduces multiple massage actions like human touch while changing kneading speed.
Kneading Type 2	Reproduces multiple massage actions by combining kneading and Shiatsu.

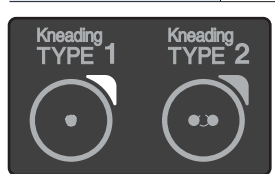

(Left illustration shows that the Kneading Type 1 action is underway.)

To start, press this button, and the light in the upper right-hand corner will light up. You can adjust the speed with the dial on the joystick.
To stop, press this button once again.

■ Roller

Action	Description
Roller 1	Stretches the spine through vertical roller movement. * To change the direction, move the joystick upward or downward.
Roller 2	Partially stretches the spine through vertical roller movement. * To adjust the center of the roller action range, move the joystick upward or downward. Also, this operation changes the movement direction.



(Above illustration shows that the Roller 2 action is underway.)

Caution

- To operate the joystick or sub remote control, press the Manual Selection Mode Button first.
- The joystick cannot move from left to right or right to left. Do not apply excess force to the joystick. →May result in damage.

[MANUAL SELECTION MODE]

[MANUAL SELECTION MODE]

MANUAL SELECTION MODE

How To Operate Manual Selection Mode

- 1 Press the POWER button.** If no selection is made within 5 minutes, the power automatically shuts off.

- 2 Press the Manual Selection Mode button on the sub remote control.** Starts Automatic Shiatsu Point Locator Function. * If no selection is made within 5 minutes, Manual Selection Mode ends.

- 3 You can adjust the shoulder position while the Shoulder Position Light on the remote control is on.** You can move the rollers upward and downward with the Shoulder Position button or joystick, too. If the adjustment is unnecessary, leave in the current state.

- 4 If joystick light still blinks, pull the joystick toward you until it remains steady.**
- 5 To start the desired massage action, you can use the remote control, joystick, and/or sub remote control. You can also save (See page 22), and start (See page 23) massaging action through the memory function.**

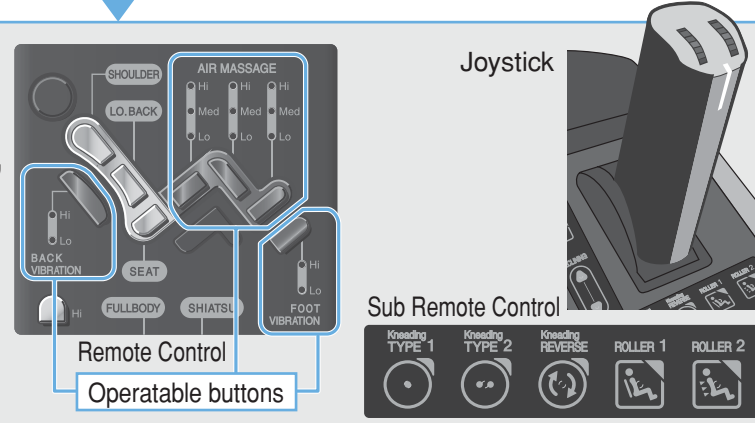
- 6 The massage action is completed in 15 minutes.** The rollers return to the storage position (upper part of seat back).
- 7 Operation Stops.**

Changing Programs From Manual Selection Mode to Healthcare Program

If you press a Healthcare Program Button during Manual Selection Mode, the rollers once return to the storage position and then start the Automatic Shiatsu Point Locator Function to shift to a Healthcare Program.

Stopping in the Middle of a Massage To stop mid-massage, press the POWER or Manual Selection Mode button. Then, the rollers stop after going back to the storage position. In an emergency or if some malfunction occurs, use the STOP button to stop the operation immediately. After confirming safety, press the POWER button. Rollers return to the storage position and stop.

Caution

- If you feel the massage is too intense, lower the intensity as described on pages 19 and 20. If this solution does not work, stop using and contact the vendor. →May result in injury if constantly used on a high stimulation level.
- If your legs or feet come out of the footrest during the massage, do not try to force them back in.

Memory Function

- You can the actions and roller positions of Kneading, Kneading Reverse, Kneading Types 1 & 2, and Tapping from the Manual Selection Mode, as well as the actions of Roller 1 & 2. The memory function is able to save the personalized massages for up to 3 people (5 minutes per person).

How To Save

- 1 Press the MEMORY button.** The selected memory button lights up. (Right illustration shows Memory 1 selected.)

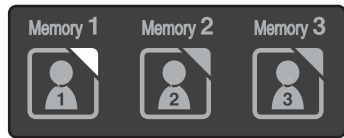
- 2 Press the Save button.** Starts saving the massage action. If you wish to overwrite data already saved, press the Save button again. The button lights up while saving, as shown on the right.

- 3 Perform the massage action you wish to save using joystick and sub remote control.**

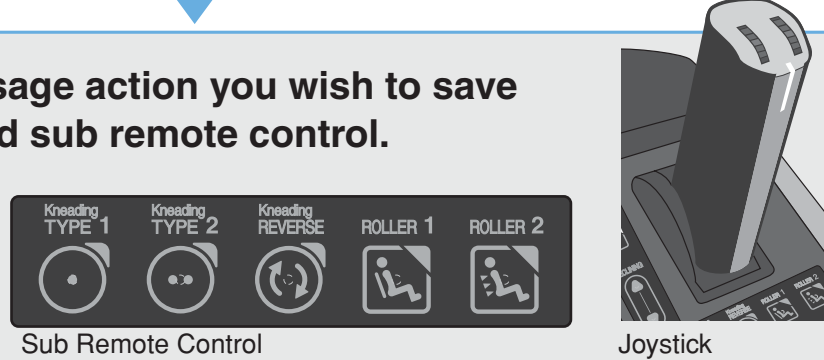
- 4 Press the Start/Stop button 5 minutes later to finish saving.**





Caution

- Saving stops when the action being saved has been stopped for more than 90 seconds after saving begins.
- Once the Manual Selection Mode stops while saving, the saving action stops accordingly.
- Massage action continues even though the recording to memory finishes.
- While saving, the massaging operation described in Step 3 above is ignored for the first time. Even when any button other than Reclining, Footrest, Foot Slide, AIR, or Vibration on the remote control or RECLINING on the sub remote control is pressed, it will also be ignored. However, if any of above is pressed again, the saving stops. If any of the POWER, STOP, Start/Stop, or Manual Selection Mode button is pressed once, the massage action the stops. In this case, if the Shoulder Position button or Back Pressure button on the remote control is pressed, it is ignored.

MANUAL SELECTION MODE

How To Recall (Start A Saved Program)

- 1 Press the Memory button.**
(Right illustration shows Memory 1 is selected.)

- 2 Press the Start/Stop button.**
Starts the previously saved message action. If there is no data, perform saving procedures on page 22. This button lights up as shown on the right during the program.

- 3 The saved message action is repeated. This action stops 15 minutes after the start of Manual Selection Mode or by pressing the Start/Stop button.**

- 4 Operation stops.**

Caution

- If you press any button other than Reclining, Footrest, Foot Slide, Air, or Vibration on the remote control, or Reclining on the sub remote control once, or operate the joystick once during the program, a message "The operation is invalid." appears. If you press any of these buttons or operate the joystick again, the message action stops. If any of the POWER, STOP, Start/Stop, or Manual Selection Mode buttons is pressed once, the message action stops. In this case, if the Shoulder Position button or Back Pressure button on the remote control is pressed, it is ignored.
- The program time differs depending on the height and weight of the person, or the reclining angle.

[MANUAL SELECTION MODE]

Guide To Combining & Adjusting Manual Selection Messages

You can combine massaging actions of your choice from among menus 1 to 5.

- A circle in the adjustment column means that particular adjustment can be made in the course of that message action.

1	Action	Remote Control	Sub Remote Control	Joystick	Description	Speed	Up/Down	Intensity	
Kneading <small>(Select 1 of 4 types of action)</small>	Kneading (Forward)				Simple kneading action.	○ (7 levels)	○	○	
	Kneading (Reverse)				Switches between Forward and Reverse.	○ (7 levels)	○	○	
	Kneading Type 1				Complex feeling like Human Touch.	○ (3 levels)	○	○	
	Kneading Type 2				Kneading combined with Shiatsu.	○ (3 levels)	○	○	
+									
Tapping	Action	Remote Control	Sub Remote Control	Joystick	Description	Speed	Up/Down	Intensity	
	Tapping				Simple tapping action.	○ (7 levels)	○	○	
+									
Roller <small>(Select either of 2 types of action)</small>	Action	Remote Control	Sub Remote Control	Joystick	Description	Speed	Up/Down	Intensity	
	Roller 1				Stretches spine.	—	○ Changes direction	○	
	Roller 2				Partially stretches spine.	—	○ Adjusts the center of action range.	○	
+									
Action to be saved or played by Memory function									
+									
4 Vibration <small>(Available for simultaneous operation)</small>	Action	Remote Control	Sub Remote Control	Joystick	Description	Speed	Up/Down	Intensity	
	Back Vibration				Vibration message on back.	—	○	○	
Foot Vibration					Vibration message on feet.	—	—	○	
+									
5 Air Massage <small>(Available for simultaneous operation)</small>	Action	Remote Control	Sub Remote Control	Joystick	Description	Speed	Up/Down	Intensity	
	Seat				Air massage on buttocks.	—	—	○	
	Calf				Air massage on calves.	—	—	○	
Foot					Air massage on feet.	—	—	○	

[MANUAL SELECTION MODE]

* Marks on above list
Right shown marks are used for items adjustable using joystick.

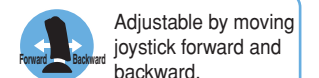
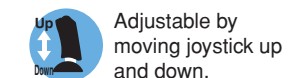



HEALTHCARE PROGRAMS

Healthcare Program Massages

- 10 courses are available, aimed at soothing or improving of health.
- Choose from this newly pre-set massage menu by simply pressing one of the Healthcare Program buttons.
- * Operation lights for Healthcare Programs light up orange.

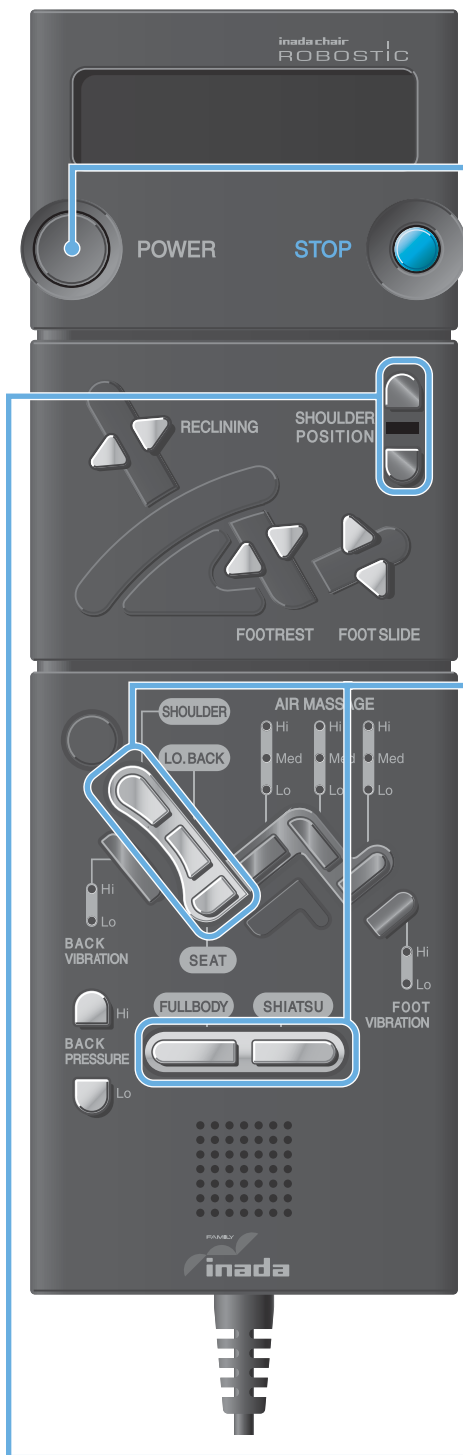
How To Operate Healthcare Program

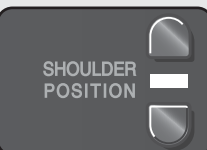

- Press the POWER button.**
 If no selection is made within 5 minutes, the power automatically shuts off.
 
- Push the button for the Healthcare Program of your choice.**
 Confirms the program selection.
 * Automatic Shiatsu Locator Function is carried out. Wait a while. Always sit as far back as possible and place your head on the pillow for precise Shiatsu Point location.
- Shoulder adjustment is available when Shoulder light is lit.**
 Use the Shoulder Position Adjustment buttons to move the rollers if desired. If no adjustment is necessary, do not use the buttons.
 * You cannot adjust shoulder position with the joystick.
 
- Starts massaging.**
- Massage completed.**
 Massage action ends, rollers return to the storage position (upper part of seat back).

Caution

- **Keep massage sessions to no more than 15 minutes in length and Area-Specific Massage of any particular area on the body to no more than 5 minutes.**
 →Continual use for extended periods of time can result in over-stimulation, which could cause the opposite of the desired effect, or even injury.
 Aim for no more than 30 minutes total massage time per day.

Adjusting Massage Actions In Healthcare Program Massages

Back Massage Intensity Adjustment

During a Healthcare Program,
 (1) press the [Hi] button to strengthen.
 (2) press the [Lo] button to soften.



- * (1) Rollers press forward while pressing [Hi]
- (2) and withdraw while pressing the [Lo] button. Thus, the massage intensity can be controlled.

Air Massage Intensity Adjustment

Starts on [Medium].

In the illustration on the right, you can change in the following order every time you press the Air Massage buttons ① Seat, ② Calf, or ③ Foot.

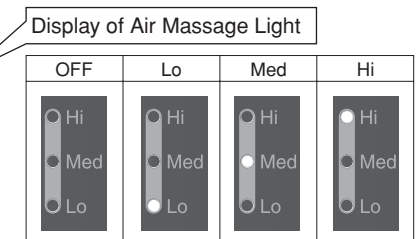
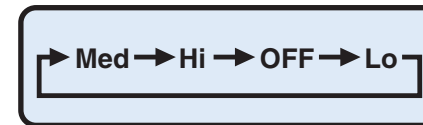

Vibration Intensity Adjustment

Starts on [Lo].

In the illustration on the right, you can change in the following order every time you press the ① Back Vibration or ② Foot Vibration button.

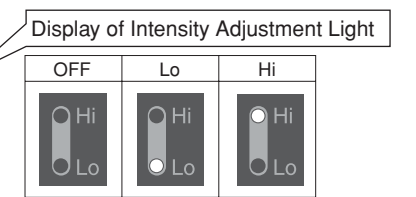
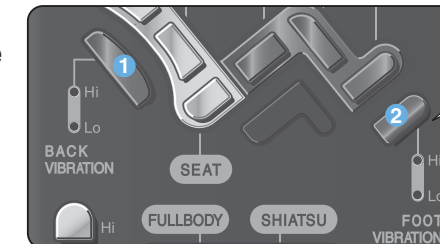
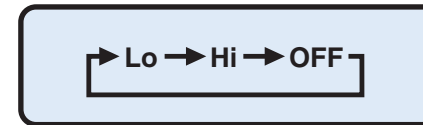

Changing Programs

Changing from one Healthcare Program to another Healthcare Program

If any other Healthcare Program button is pressed during a Healthcare Program, rollers once return to the storage position to restart with Automatic Shiatsu Point Locator Function.

Changing from a Healthcare Program to Manual Selection Mode

If you press a Manual Selection button during Healthcare programs, the shift occurs in either way below.

- Rollers are once stored during Automatic Shiatsu Point Locator Function before shifting to Manual Selection Mode.
- If Automatic Shiatsu Point Locator Function has already finished, you can shift to Manual Selection Mode directly.

Stopping in the Middle of a Massage

To stop during a massage, press the POWER button. Operation stops after storing the rollers. Press the STOP button in an emergency or when some problem occurs. Massage action stops at that point.

After a safety check, press the POWER button again to bring the rollers back to the storage position. Then, the power will be turned off.

Caution

- **If you feel the massage is too intense, lower the intensity according to the "Adjusting Massage Actions In Healthcare Program Massages" on this page. If this solution does not work, stop using and contact the vendor.**
 →May result in injury if constantly used on a high stimulation level.
- **Do not place hands or feet into the roller tracks or into the space between the seat back and the seat or into moving parts.**
Do not wear hard objects like accessories while using this chair.
- **If your legs or feet come out of the footrest during the massage, do not try to force them back in.**

TROUBLESHOOTING

Repairs or disassembly may not be performed by anyone other than an authorized serviceperson.

If there is still a problem after trying the solutions given in this troubleshooting guide, stop using the chair immediately so as to prevent accident or injury and unplug the chair from the wall outlet. Contact the vendor for assistance.

Problem	<p>Noise during chair operation:</p> <ul style="list-style-type: none"> ● During Tapping and Kneading & Tapping ● Sound of air pump ● Sound of rollers rubbing against the seat cover ● Vibrating mechanism noise ● Sound of reclining seat back mechanism ● Sound of air massage cushions
Cause & Solution	<p>These noises are a normal part of the chair's operation and do not affect its performance in any way.</p>
Problem	<p>Remote control buttons do not seem to be activating normally.</p>
Cause & Solution	<p>Check for the following possible problems:</p> <ol style="list-style-type: none"> 1) Is the power cord fully plugged into the wall outlet? 2) Is the power cord fully plugged into the connector at the back of the chair? 3) Is the main POWER switch in back of the chair set to ON?
Problem	<p>Remote control display shows the message, "Restart the main POWER switch."</p>
Cause & Solution	<p>Turn the main POWER switch on the back of the chair to OFF, wait 5 seconds and then turn it ON again.</p> <ol style="list-style-type: none"> 1) If the chair returns to normal, no further action is needed. 2) Check to be sure that the footrest connector is fully attached. 3) If the same message is displayed again, stop using the chair and unplug it from the wall outlet. Contact the vendor for assistance.
Problem	<p>The Automatic Shiatsu Point Locator Function is not working properly (The height of rollers does not fit the shoulders).</p>
Cause & Solution	<p>Sit further back in the chair so your head rests firmly on the seat back. Or, you can adjust the shoulder position with the Shoulder Position button just after the Shiatsu points are located.</p>
Problem	<p>The footrest adjusting function is not working properly (The footrest does not reach the bottom of my feet).</p>
Cause & Solution	<p>Sit with your ankles touching the back of the foot unit so that the sensors (located near the ankle) can function properly. If your ankles do not reach the back of the foot unit, use the footrest buttons to adjust the angle.</p> <p>See page 13 for details.</p>

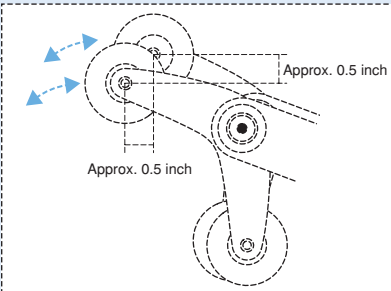
Problem	<p>Massage action stops in the middle of the program.</p>
Cause & Solution	<p>Turn the main POWER switch on the back of the chair to OFF. Wait 5 seconds and then turn it ON again.</p> <ol style="list-style-type: none"> 1) If chair returns to normal, no further action is needed. 2) If this doesn't fix the problem, stop using the chair immediately to prevent any accident or injury. Unplug the chair from the wall outlet and contact the vendor for assistance.
Problem	<p>The rollers stop during the massage.</p>
Cause & Solution	<p>Sometimes when the massage speed is slow and there is too much pressure on the rollers, they can stop moving temporarily. This is not breakage. Just slightly lift your body.</p>
Problem	<p>The rollers moved up to the top and then stopped.</p>
Cause & Solution	<p>The auto timer will cause the rollers to move up to the top of the chair when the massage time is finished, so as not to interfere with your movements when getting out of the chair. If you want to continue the massage, press the POWER button on the remote control again.</p>
Problem	<p>The right and left rollers are out of alignment.</p>
Cause & Solution	<p>The rollers are designed to provide for the alternating tapping function, so in the stopped position they are sometimes out of line -- this is part of their design and there is nothing wrong with the chair.</p>
	
Problem	<p>If I try to raise or lower the footrest or use the Foot Slide function during the leg or foot massage, the chair stops.</p>
Cause & Solution	<p>For safety purposes, the air pressure massage is designed to stop if the footrest or foot slide is activated during the massage.</p>
Problem	<p>The reclining function does not work.</p>
Cause & Solution	<p>Check if there is anything caught between reclining seat back and control box, or armrest and side cover. The reclining safety unit may have been activated.</p>

[TROUBLESHOOTING]

[TROUBLESHOOTING]

TROUBLESHOOTING

Problem Saving function stops.

Cause & Solution The auto timer function prevents saving if the action to be saved has not been started or has stopped for more than 90 seconds after the saving function was initiated. The saving action stops automatically after 5 minutes.

Problem The joystick panel does not close.

Cause & Solution Check if the joystick panel is caught in something around the joystick, and that the joystick has been fully pulled toward you.

Problem The joystick panel came off.

Cause & Solution It is designed to detach for safety reasons. Set the Joystick panel so that the slit on the joystick panel fits the rotation axis convex of the joystick panel joint on the right armrest. See the illustration on the right.
* Do not use with panel detached.

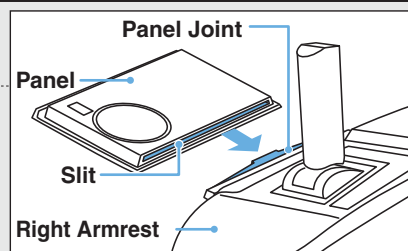

[TROUBLESHOOTING]

FAQ

Q How do I make the massage deeper?

A Use the Intensity button on the remote control to adjust the intensity of the Healthcare Program. In the Manual Selection Mode, operate the joystick. If you still feel the massage is not strong enough, lower the reclining seat back and sit deeply to put more weight on the reclining seat back. You can also remove the buffer pad from inside the back pad to strengthen the intensity.

Q How do I make the massage lighter?

A Use the Intensity button on the remote control to adjust the intensity of the Healthcare Program. In the Manual Selection Mode, operate the joystick. If you still feel the massage is strong, replace the buffer pad inside the back pad with the accessory buffer pad (thicker). You can also raise the reclining seat back to lessen the intensity.

Q I spilled water on the chair. What should I do?

A Immediately turn the main POWER switch to OFF, and then unplug the chair from the wall outlet. Contact the vendor for assistance.

Q Can you use the chair even if you are overweight?

A We recommend the chair be used by people weighing up to 220 lbs. If you weigh more than that, try sitting lightly in the chair, and not reclining too far.

[FAQ]

CARE & STORAGE

Storage

- After wiping off any dust or dirt, store your chair in a place that is relatively dry.
- If you are not going to use the chair for some time, put a cover on it that will protect it from dust and dirt.
- Pets can sometimes chew on power cords, so try to keep pets away from the chair even when it's being stored.

Caution

- Do not install the chair where it can come into contact with direct heat, such as direct sunlight or a radiator.

Care and Maintenance

Caution

- When cleaning or caring for your chair, make sure to unplug the chair from the wall first. Do not touch the power cord with wet hands.

[Caring for the Back Pad, Headrest, and Covers]

Use a damp cloth that has been soaked in warm water and a mild detergent and then thoroughly wring out before cleaning any spots or grime.

Caution

- The fabric color can change if the chair is in contact with vinyl covers or some wall coverings for a prolonged period of time.
- Do not iron.

[Care and Maintenance of Remote Control, Joystick, and Control Box]

Wipe dirt off the remote control, sub remote control, joystick, and / or control box with a dry cloth.

- Never use a damp or wet cloth. → May result in mechanical failure.

[Caring for Other Plastic Parts]

First, soak a soft cloth in lukewarm water in which a small amount of neutral detergent has been added. Then, thoroughly wring it out before wiping the parts in question.

- Do not use alcohol based or other household cleaning products or abrasives because they can scratch or crack the finish and/or cause color to fade.

Removing Headrest and Back Pad

Please follow these instructions when removing the headrests or back pad.

* To put them back on, follow these instructions in reverse.

- (1) Undo the velcro that holds the headrest to the back pad and remove the headrest.
- (2) Unzip the zipper connecting the seat back and the reclining seat back covers.
- (3) Undo the snaps that hold the back pad on and remove the back pad.

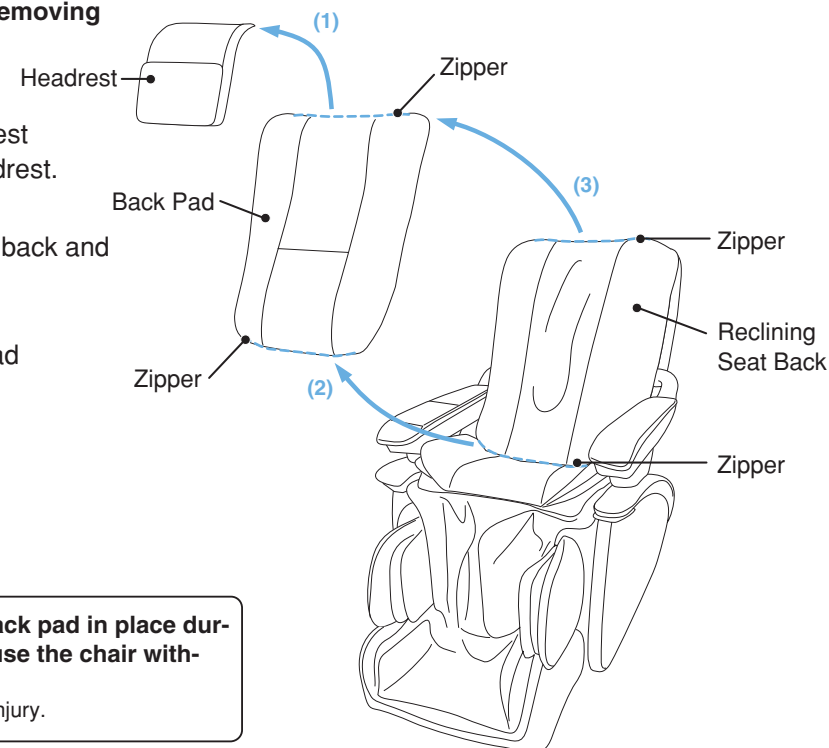

Caution

- Be sure to keep the back pad in place during massage. Do not use the chair without the back pad.
→ May result in personal injury.

CUSTOMER SERVICE AND WARRANTY

1. Warranty

A warranty card is provided separately by each vendor.

Please read the contents carefully and keep it in a safe place. (You will need the card to facilitate warranty repairs)

If the chair is to be used outside the home (in a commercial setting, for example), fees will be charged for repairs even while the chair is under warranty.

2. Repairs & Service

Before calling for repairs or service, use the Troubleshooting guide on pages 27-29 to see if the problem can be solved easily.

If the problem persists, contact the vendor for assistance. Have the following information ready.

- 1) Your name, address, and phone number
- 2) Product name and model number (see page 34)
- 3) Serial No. (see the Serial No. label on the back cover of the chair)
- 4) Date of purchase
- 5) Trouble status
- 6) Proof of purchase

● If the warranty is valid:

Show the vendor the warranty card.

A service charge may apply, subject to the nature of the trouble and/or repair according to the terms of the warranty. See the warranty for full details.

● If the warranty has expired:

Consult the vendor.

If the product can be repaired, the vendor will give you an estimate of the cost to repair the product.

● Replacement parts stock:

We will stock service parts (except fabric) of this product for at least six years after terminating the production of this model. Service parts refer to those necessary for maintaining the intended performance of the product.

● For more information on service:

Contact the vendor.

REGULAR MAINTENANCE FOR SAFETY

Regular Maintenance Will Preserve the Life of Your Chair

Have you experienced any of these problems?

- The chair does not start with the main POWER switch set to on.
- The power cord has been cracked or scratched.
- The power cord or plug becomes abnormally hot.
- The chair produces a burnt smell, abnormal sound or vibration.
- The auto timer function does not work in some cases.
- The fabric is torn where it comes into contact with the rollers or air cells.
- Other failures.

If you find anything listed above, stop using and unplug the power cord from the outlet to prevent failure or accident. Be sure to contact with the vendor where you purchased for maintenance.

To Use Safely

- * Durable years vary depending on condition of use.
- * After about five years of use, a professional inspection is recommended even if there are no symptoms or problems.
For inspection fees, contact the vendor.

SPECIFICATIONS

Name & Model Number	Inada Chair ROBOSTIC HCP-D6A	
Power Supply	AC120V	
Power Consumption	170W	
Power Frequency	60Hz	
Rated Time	30 minutes	
Upper Body	Kneading Speed	7 levels, from minimum 10 times/minute to maximum 40 times/minute
	Tapping Speed	7 levels, from minimum 188 times/minute to maximum 480 times/minute
	Roller Width	No level (Minimum: approx. 2.4 inches, Maximum: approx. 7 inches)
	Vertical Speed	One full cycle (top to bottom to top again) in approx. 20 seconds
	Back Stroke Range	Approx. 25 inches (in partial roller massage approx. 6 inches)
Pre-set Programs	Healthcare Programs: 10 types (5 types x 2 patterns) (with Automatic Shiatsu Point Locator Function)	
Manual Selection	6 types (include Automatic Shiatsu Point Locator Function)	
Vibrating Function	2 types: Foot and Back; Toggles between 2 levels of intensity for each location (Seat vibration is available only in the Seat program.)	
Air Massage	Air pressure approx. 32kPa	
Auto Timer	Approx. 15 minutes (Healthcare Programs vary in duration)	
Footrest Adjustment Range	Approx. 11 inches (with automatic Foot Slide adjustment function)	
Reclining Angle	Approx. 120° -170° from floor level continuous motion (Automatic reclining)	
Chair Dimensions	Approx. 31 x 56 (82) x 48 (36) inches Numbers in () represent dimensions when fully reclined and with footrest flat	
Weight	Approx. 249 lbs.	
Outer Covering	Synthetic leather (with antibacterial/soil resistant finish)	
Accessories	Remote Control Stand, Power Cord, T-shaped Wrench, Shiatsu Foot Pad, Buffer Pad (Thick), Headrest (Small)	